

PROJECT
TYPE
SPECIFIER
QUANTITY
DATE

## TETRA PARCO POST

### E9B134-

base number	Color	Finish
	Temperature	Options

- To build a product code in our configurator select the specify button on the base model # product page
- To build a manual product code on this datasheet choose from the options listed below in blue font and add the suffix to the base model #

#### GENERAL

Series: Tetra
Subseries: Tetra Parco
Brand: Platek
Division: Exterior
Mounting Type: Post
Mounting Location: Above Ground
Subcategory: Bollard

#### PHYSICAL

Shape: Rectangle
Length (mm): 140
Length (in): 5 1/2
Width (mm): 140
Width (in): 5 1/2
Height (mm): 1330
Height (in): 52 3/8
Light Distribution: Direct
Weight (kg): 12
Weight (lbs): 26.46
Screws: A4 stainless steel
Diffuser: Clear tempered glass
Fixture Finish: <a href="#">BLK</a> / <a href="#">WHI</a> / <a href="#">GRY</a> / <a href="#">COR</a> / <a href="#">ANT</a> / <a href="#">BRZ</a>
Fixture Material: Extruded Aluminum

#### ELECTRICAL

Lamp Type: LED
Input Wattage (W): 28
Total Output Wattage (W): 24
Dimming: Non-Dimming / Phase Dimming (120vac Only)
Driver Included: Yes
Driver Location: Integrated
Driver Type: Constant Current - 120 / 277Vac
Driver Class: Class 2
Input Voltage (V): 120 - 277
Constant Current (MA): 700
Upon Request: Remote: 0-10Vdc dimming

#### LED

Color Temperature (°K): <a href="#">3000</a> / <a href="#">4000</a>
Max. Delivered Lumen (lm): 1620 / 1685
Nominal Lumen (lm): 3685 / 3830
CRI: >80 CRI
Lamp Life (hrs): 60000

#### OPTICAL

#### RATINGS AND CERTIFICATIONS

Certified By: Certified for North American Standards
IP rating: IP65
IK Rating: IK10
Bug Rating: B1 U0 G1



## TETRA PARCO POST

E9B134-

PROJECT

TYPE

SPECIFIER

QUANTITY

DATE



E

## TETRA PARCO POST

### E9B135-

base number    Color    Finish  
 Temperature    Options

- To build a product code in our configurator select the specify button on the base model # product page
- To build a manual product code on this datasheet choose from the options listed below in blue font and add the suffix to the base model #

#### GENERAL

Series: Tetra  
 Subseries: Tetra Parco  
 Brand: Platek  
 Division: Exterior  
 Mounting Type: Post  
 Mounting Location: Above Ground  
 Subcategory: Pedestrian

#### PHYSICAL

Shape: Rectangle  
 Length (mm): 140  
 Length (in): 5 1/2  
 Width (mm): 140  
 Width (in): 5 1/2  
 Height (mm): 1930  
 Height (in): 76  
 Light Distribution: Direct  
 Screws: A4 stainless steel  
 Diffuser: Clear tempered glass  
 Fixture Finish: [BLK](#) / [WHI](#) / [GRY](#) / [COR](#) / [ANT](#) / [BRZ](#)  
 Fixture Material: Extruded Aluminum

#### ELECTRICAL

Lamp Type: LED  
 Input Wattage (W): 28  
 Total Output Wattage (W): 24  
 Dimming: Non-Dimming / Phase Dimming (120vac Only)  
 Driver Included: Yes  
 Driver Location: Integrated  
 Driver Type: Constant Current - 120 / 277 Vac  
 Driver Class: Class 2  
 Input Voltage (V): 120 - 277  
 Constant Current (MA): 700  
 Upon Request: (Not included - see components [IP65 or higher enclosure to be supplied by others]) Remote: 0-10Vdc dimming / Non-dimming 120/277Vac

#### LED

Color Temperature (°K): [3000](#) / [4000](#)  
 Max. Delivered Lumen (lm): 1620 / 1685  
 Nominal Lumen (lm): 3685 / 3830  
 CRI: >80 CRI  
 Lamp Life (hrs): 60000

#### OPTICAL

#### RATINGS AND CERTIFICATIONS

Certified By: Certified for North American Standards  
 IP rating: IP65  
 IK Rating: IK10  
 Bug Rating: B1 U0 G1

PROJECT
TYPE
SPECIFIER
QUANTITY
DATE



## TETRA PARCO POST

E9B135-

PROJECT

TYPE

SPECIFIER

QUANTITY

DATE



E

PROJECT	_____
TYPE	_____
SPECIFIER	_____
QUANTITY	_____
DATE	_____

## TETRA INCASSO RECESSED

### E91470-

base number    Color    Lens  
 Temperature    Options

- To build a product code in our configurator select the specify button on the base model # product page
- To build a manual product code on this datasheet choose from the options listed below in blue font and add the suffix to the base model #

#### GENERAL

Series: Tetra  
 Subseries: Tetra Incasso  
 Brand: Platek  
 Division: Exterior  
 Mounting Type: Recessed  
 Mounting Location: In-Ground  
 Subcategory: Drive Over

#### PHYSICAL

Shape: Rectangle  
 Length (mm): 1000  
 Length (in): 39 3/8  
 Width (mm): 130  
 Width (in): 5 1/8  
 Height (mm): 68  
 Height (in): 2 11/16  
 Light Distribution: Uplight  
 Weight (kg): 6.7  
 Weight (lbs): 14.77  
 Load Resistance (kg): 2000  
 Load Resistance (lbs): 4409  
 Installation Requirement: Installation in sleeve set in concrete with a 20-30 cm gravel drain bed  
 Screws: A4 stainless steel  
 Diffuser: Clear tempered glass  
 Gasket: Gore-Tex valve to prevent condensation inside the fitting.  
 Fixture Finish: SST  
 Fixture Material: Extruded Aluminum

#### ELECTRICAL

Lamp Type: LED  
 Input Wattage (W): 21  
 Total Output Wattage (W): 18 / RGBW 35W  
 Dimming: Non-Dimmable  
 Control Gear: DMX  
 Driver Included: Yes (excluding RGBW)  
 Driver Location: Integrated / RGBW - Remote  
 Driver Type: White LED - Constant Voltage - 120Vac  
 Driver Class: Class 2  
 Input Voltage (V): 120 - 277  
 Output Voltage (V): 24  
 Constant Current (MA): RGBW 500  
 Upon Request: Remote: DMX / Non-dimming 120/277Vac / 0-10Vdc dimming / Phase dimming @120Vac only

#### LED

Number of LEDs: 18 / RGBW 24  
 Color Temperature (°K): 3000 / 4000 / RGBW  
 Max. Delivered Lumen (lm): 1540 - 1600  
 Nominal Lumen (lm): 2520 / 2610  
 CRI: >80 CRI  
 Lamp Life (hrs): 60000

#### OPTICAL

Optic°: 12 / 26 / 40 / Elliptical

#### RATINGS AND CERTIFICATIONS

Certified By: Certified for North American Standards

IP Rating: IP67  
 © 2024, T 1800-388-3382, F 416-247-9319, www.zaneen.com

For international specifications by adding 'INT' at the end of the existing Model #. For assistance on 'custom' specifications, contact zteam@zaneen.com.

As a manufacturer of the best product, we reserve the right to change specifications or materials without notice. The most recent specification sheets are found at zaneen.com

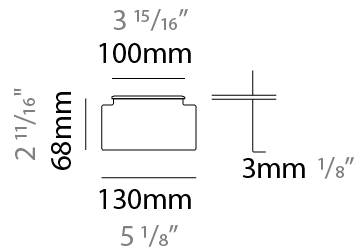
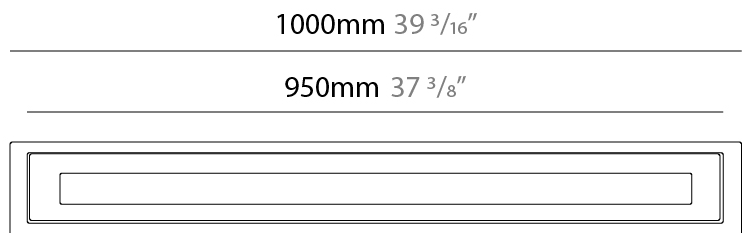
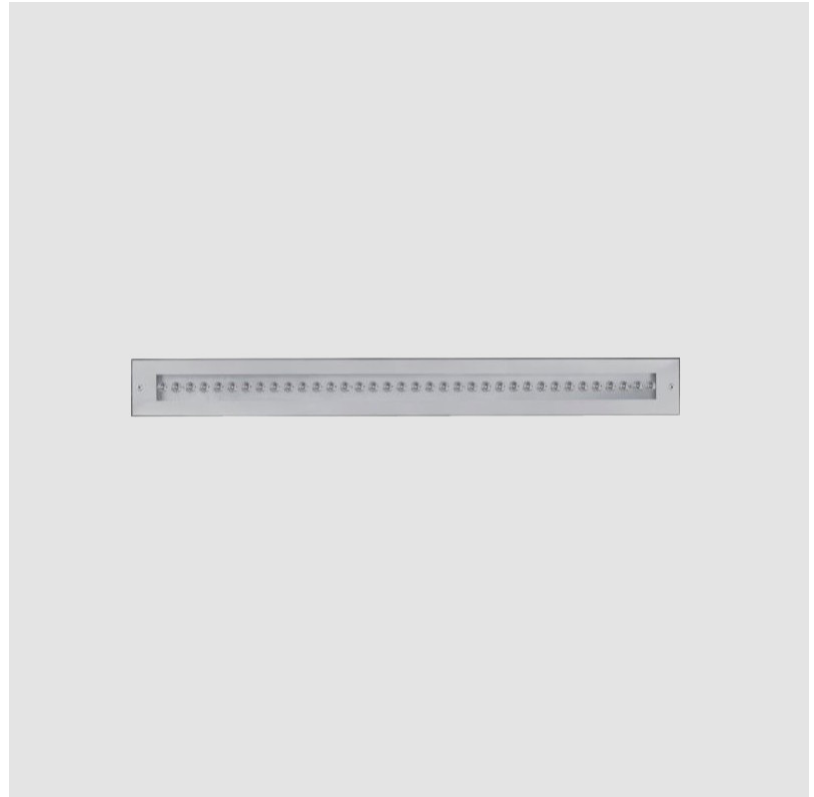

## TETRA LINEAR SURFACE

**E9W165-** - -  
 base number    Color    Finish    Lens  
                          Temperature    Options    Options

- To build a product code in our configurator select the specify button on the base model # product page
- To build a manual product code on this datasheet choose from the options listed below in blue font and add the suffix to the base model #

### GENERAL

Series: Tetra  
 Subseries: Tetra Linear  
 Brand: Platek  
 Division: Exterior  
 Mounting Type: Surface  
 Mounting Location: Wall  
 Subcategory: Wallwash

### PHYSICAL

Shape: Rectangle  
 Length (mm): 904  
 Length (in): 35 <sup>9</sup>/<sub>16</sub>  
 Width (mm): 65  
 Width (in): 2 <sup>9</sup>/<sub>16</sub>  
 Height (mm): 65  
 Depth (mm): 136  
 Height (in): 2 <sup>9</sup>/<sub>16</sub>  
 Depth (in): 5 <sup>3</sup>/<sub>8</sub>  
 Light Distribution: Adjustable / Direct  
 Weight (kg): 4  
 Weight (lbs): 8.8  
 Screws: A4 stainless steel  
 Diffuser: Clear tempered glass  
 Gasket: Gore-Tex valve to prevent condensation inside the fitting.  
 Fixture Finish: [BLK](#) / [WHI](#) / [GRY](#) / [COR](#) / [ANT](#) / [BRZ](#)  
 Fixture Material: Extruded Aluminum

### ELECTRICAL

Lamp Type: LED  
 Input Wattage (W): 21  
 Total Output Wattage (W): 18  
 Dimming: Non-Dimmable  
 Driver Included: Yes  
 Driver Location: Integrated  
 Driver Type: Constant Voltage - 120Vac  
 Driver Class: Class 2  
 Input Voltage (V): 120 - 277  
 Output Voltage (V): 24  
 Upon Request: (Not included - see components [IP65 or higher enclosure to be supplied by others]) Remote: Non-dimming 120/277Vac

### LED

Number of LEDs: 18  
 Color Temperature (°K): [3000](#) / [4000](#)  
 Max. Delivered Lumen (lm): 1500 / 1560  
 Nominal Lumen (lm): 2520 / 2610  
 CRI: >80 CRI  
 Lamp Life (hrs): 60000

### OPTICAL

Optic°: [12](#) / [40](#) / [Elliptical](#)  
 Adjustability: Tilt ±45°

### RATINGS AND CERTIFICATIONS

Certified By: Certified for North American Standards  
 IP rating: IP65  
 IK Rating: IK07  
 Bug Rating: B2 U1 G0

Zaneen Group Inc. © 2024, T 1800-388-3382, F 416-247-9319, www.zaneen.com

Available for International specifications by adding 'INT' at the end of the existing Model #. For assistance on 'custom' specifications, contact zteam@zaneen.com. In a constant effort to supply the best product, we reserve the right to change specifications or materials without notice. The most recent specification sheets are found at zaneen.com

PROJECT
TYPE
SPECIFIER
QUANTITY
DATE

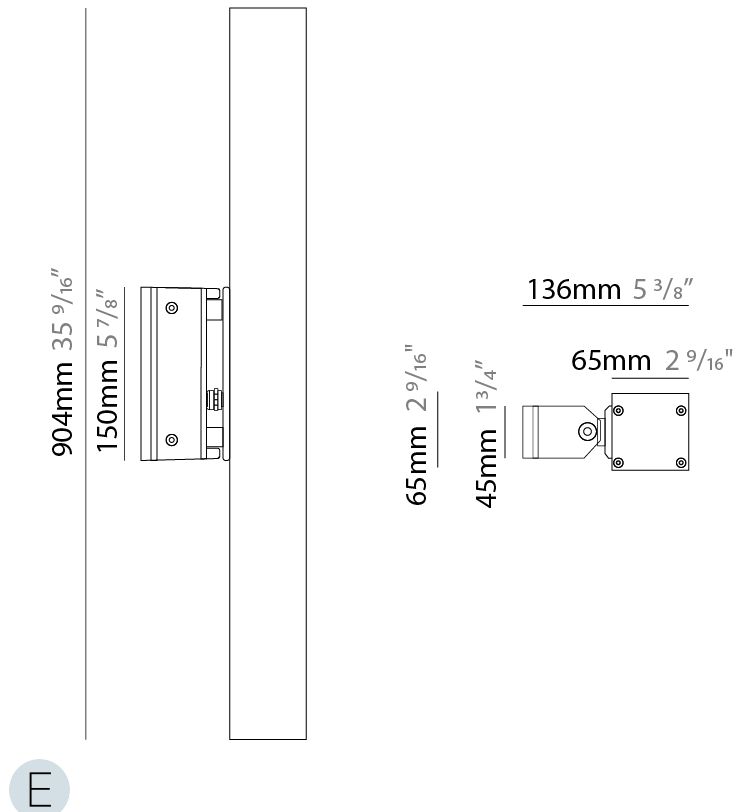

## TETRA LINEAR SURFACE

E9W165-

PROJECT

TYPE

SPECIFIER

QUANTITY

DATE

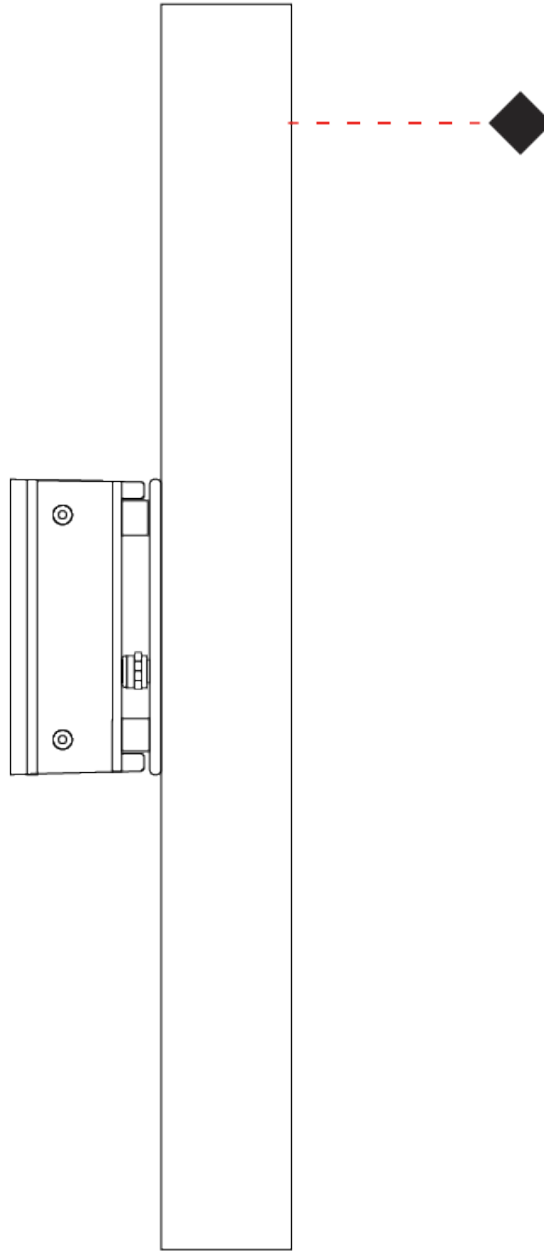

E

## TETRA CORNICHE SURFACE

**E9W215-** - -  
 base number    Color    Finish    Lens  
                          Temperature    Options    Options

- To build a product code in our configurator select the specify button on the base model # product page
- To build a manual product code on this datasheet choose from the options listed below in blue font and add the suffix to the base model #

### GENERAL

Series: Tetra  
 Subseries: Tetra Corniche  
 Brand: Platek  
 Division: Exterior  
 Mounting Type: Surface  
 Mounting Location: Wall  
 Subcategory: Wallwash

### PHYSICAL

Shape: Rectangle  
 Length (mm): 904  
 Length (in): 35 <sup>7</sup>/<sub>16</sub>"  
 Width (mm): 65  
 Width (in): 2 <sup>9</sup>/<sub>16</sub>"  
 Height (mm): 73  
 Height (in): 2 <sup>7</sup>/<sub>8</sub>"  
 Light Distribution: Adjustable / Direct  
 Weight (kg): 4  
 Weight (lbs): 8.8  
 Screws: A4 stainless steel  
 Diffuser: Clear tempered glass  
 Gasket: Gore-Tex valve to prevent condensation inside the fitting.  
 Fixture Finish: [BLK](#) / [WHI](#) / [GRY](#) / [COR](#) / [ANT](#) / [BRZ](#)  
 Fixture Material: Extruded Aluminum

### ELECTRICAL

Lamp Type: LED  
 Input Wattage (W): 21  
 Total Output Wattage (W): 18  
 Dimming: Non-Dimmable  
 Driver Included: Yes  
 Driver Location: Integrated  
 Driver Type: Constant Voltage - 120Vac  
 Driver Class: Class 2  
 Input Voltage (V): 120 - 277  
 Output Voltage (V): 24  
 Upon Request: (Not included - see components [IP65 or higher enclosure to be supplied by others]) Remote: Non-dimming 120/277Vac

### LED

Number of LEDs: 18  
 Color Temperature (°K): [3000](#) / [4000](#)  
 Max. Delivered Lumen (lm): 1300 / 1600  
 Nominal Lumen (lm): 2520 / 2610  
 CRI: >80 CRI  
 Lamp Life (hrs): 60000

### OPTICAL

Optic°: [13](#) / [26](#) / [40](#) / Elliptical  
 Pitch: 0-15° rotation angle

### RATINGS AND CERTIFICATIONS

Certified By: Certified for North American Standards  
 IP rating: IP66  
 IK Rating: IK07  
 Bug Rating: B2 U1 G0

PROJECT
TYPE
SPECIFIER
QUANTITY
DATE

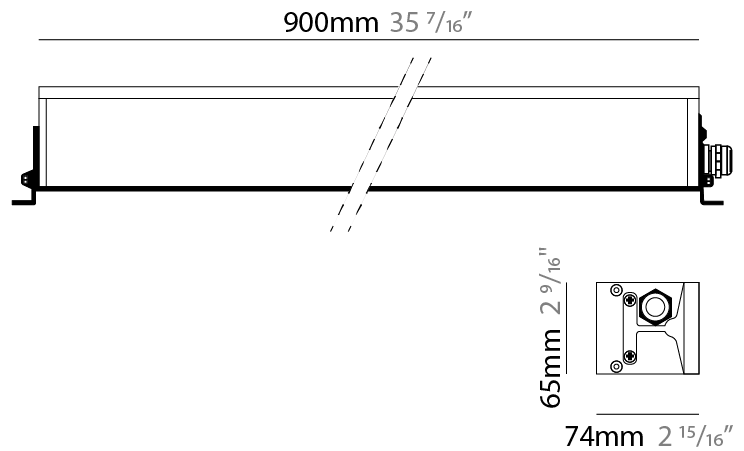



## TETRA CORNICHE SURFACE

E9W215-

PROJECT

TYPE

SPECIFIER

QUANTITY

DATE

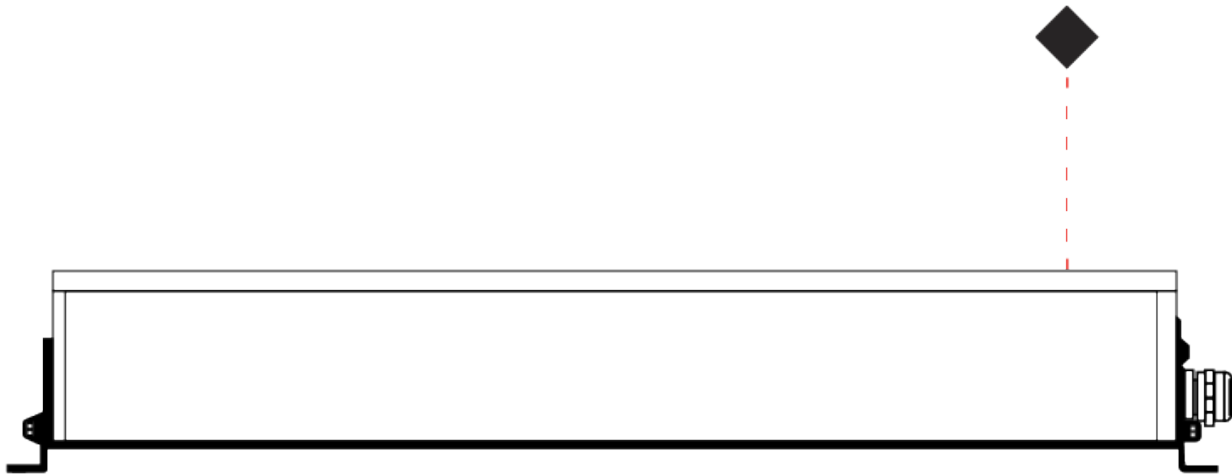

E

PROJECT
TYPE
SPECIFIER
QUANTITY
DATE

## TETRA APPLIQUE SURFACE

**E9W290-** - -  
 base number    Color    Finish    Lens  
                          Temperature    Options    Options

- To build a product code in our configurator select the specify button on the base model # product page
- To build a manual product code on this datasheet choose from the options listed below in blue font and add the suffix to the base model #

### GENERAL

Series: Tetra  
 Subseries: Tetra Applique  
 Brand: Platek  
 Division: Exterior  
 Mounting Type: Surface  
 Mounting Location: Wall  
 Subcategory: Wall Effect

### PHYSICAL

Shape: Rectangle  
 Length (mm): 60  
 Length (in): 2 <sup>3</sup>/<sub>8</sub>  
 Height (mm): 380  
 Depth (mm): 225  
 Height (in): 14 <sup>15</sup>/<sub>16</sub>  
 Depth (in): 8 <sup>7</sup>/<sub>8</sub>  
 Light Distribution: Direct / Indirect  
 Weight (kg): 6  
 Weight (lbs): 13.2  
 Screws: A4 stainless steel  
 Diffuser: Clear tempered glass  
 Fixture Finish: [BLK](#) / [WHI](#) / [GRY](#) / [COR](#) / [ANT](#) / [BRZ](#)  
 Fixture Material: Extruded Aluminum

### ELECTRICAL

Lamp Type: LED  
 Input Wattage (W): 20.65  
 Total Output Wattage (W): 17.59  
 Dimming: Non-Dimming / Phase Dimming (120vac Only)  
 Driver Included: Yes  
 Driver Location: Integrated  
 Driver Type: Constant Current - Universal  
 Driver Class: Class 2  
 Input Voltage (V): 120 - 277  
 Constant Current (MA): 350  
 Upon Request: (Not included - see components [IP65 or higher enclosure to be supplied by others]) Remote: 0-10Vdc dimming

### LED

Number of LEDs: 18  
 Color Temperature (°K): [3000](#) / [4000](#)  
 Max. Delivered Lumen (lm): 1840 / 1910  
 Nominal Lumen (lm): 2520 / 2610  
 CRI: >80 CRI  
 Lamp Life (hrs): 60000

### OPTICAL

Optic°: [Double Emission](#)  
 Beam Angle: 2x9 / 2x44 / ELL-ELL / 9-44

### RATINGS AND CERTIFICATIONS

Certified By: Certified for North American Standards  
 IP rating: IP65  
 IK Rating: IK07  
 Bug Rating: B1 U4 G0

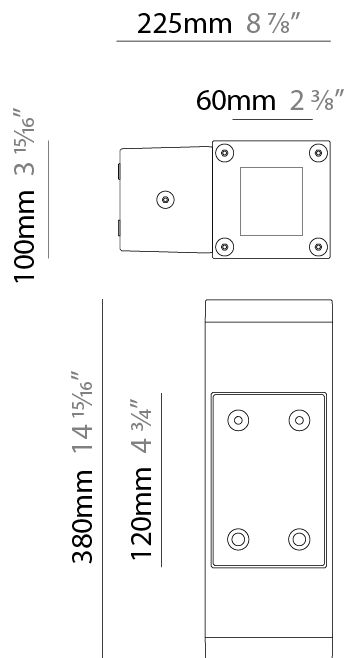

## TETRA APPLIQUE SURFACE

E9W290-

PROJECT

TYPE

SPECIFIER

QUANTITY

DATE

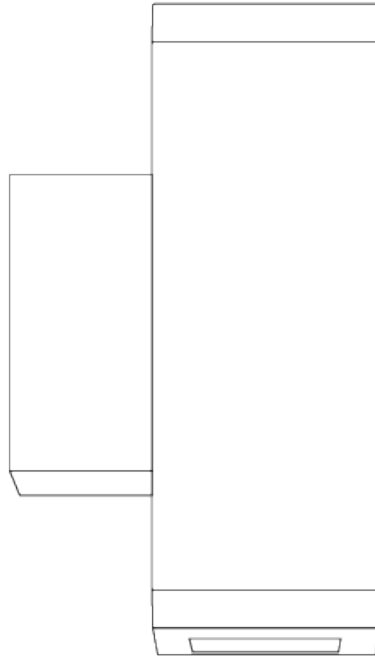

PROJECT \_\_\_\_\_

TYPE \_\_\_\_\_

SPECIFIER \_\_\_\_\_

QUANTITY \_\_\_\_\_

DATE \_\_\_\_\_

### Fixture Finish

Black - BLK

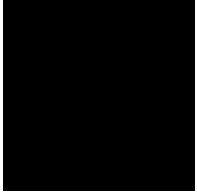

White - WHI

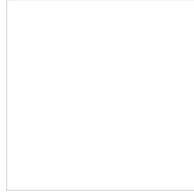

Gray - GRY

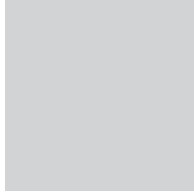

Corten - COR



Anthracite - ANT



Bronze - BRZ

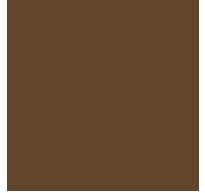

Stainless Steel Inox - SST

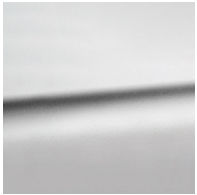

**Digital:** Not all screens are calibrated the same, and therefore, colors will appear differently between screens.

**Physical:** When texture is involved, there will be variations in color, character and tone within a product series and between product families.



### LEGEND

	floor-mounted		pivotal		special LED (upon request) RGB, RGBW, tunable, gold+, meat+, art+, fashion+
	wall and ceiling: recessed and surface mounted		rotating		warm dim / natural dimming LED
	ceiling-mounted and wall-mounted		illuminate tilted		rechargeable battery powered
	wall-mounted		color of suspension cable		fixture with natural vivid LED (upon request)
	omni-directional light distribution		length of suspension cable		color rendering index
	direct light distribution		reflector degree selection		color temperature
	direct/indirect light distribution		super spot		lumen (luminous flux)
	indirect light distribution		lens		efficacy (lumens per watt)
	asymmetric light distribution		lens pack		Unified Glare Rating (UGR) range from 5-40
	aura light distribution		shine ring		marine grade (AISI 316 stainless steel)
	round wall or ceiling cut-out		integrated shine ring with diffuser		walk on
	square wall or ceiling cut-out		free individual colors 01-29		drive on
	the supplied jig specifies the cutout dimensions		individual colors: 00 (free of charge), 01-25 (extra charge)		Dark Sky Compliance
	minimum distance (meters) lamp - object		luminaire part to be colored (F1)		Americans with Disabilities Act (less than 4" off the wall located between 27"-84" from floor)
	recessed depth		luminaire part to be colored (F2)		lamp protected against explosion
	ceiling thickness in mm		luminaire part to be colored (F3)		blown glass using traditional methods by master glass blower
	ceiling thickness selection		luminaire part to be colored (F4)		acoustic material
	dimmable DP (phase), DV (0-10V), DD (dali), DS (step-dim)		luminaire part to be colored (F5)		protection class I, protection insulation
	included or excluded LED driver/transformer/control gear		color of 3-circuit adaptor		protection class II, protection insulation
	separately switchable		indirect diffuser		ETL Certified to UL and CSA Standards
	sensor		direct diffuser		UL Certified to UL and CSA Standards
	remote control		ball-proof (upon request)		CSA Certified to UL and CSA Standards
	available upon request		accessory		Certified for North American Standards

### IP RATING

	protected against ingress of solid bodies greater than 12.5mm (finger)
	protected against ingress of solid bodies greater than 2.5mm protected against sprays of water up to 60 degrees from the vertical (rain)
	protected against ingress of solid bodies greater than 1mm (wire) no protection against the ingress of moisture
	protected against ingress of solid bodies greater than 1mm (wire) protected against sprays of water up to 60 degrees from the vertical (rain)
	protected against ingress of solid bodies greater than 1mm (wire) protected against water splashed from all directions
	protected against limited ingress of dust (wet rooms/covered outdoor areas) protected against water splashed from all directions
	protected against ingress of dust protected against jets of water
	protected against ingress of dust protected against powerful jets of water or heavy seas
	protected against ingress of dust protected against immersion of water between 15cm - 1m for 30 minutes
	protected against ingress of dust protected against immersion of water under pressure for long periods

### IK RATING

	protected against 0.14 joules impact (equivalent to 0.25kg mass dropped from 56mm above the surface)
	protected against 0.2 joules impact (equivalent to 0.25kg mass dropped from 80mm above the surface)
	protected against 0.35 joules impact (equivalent to 0.25kg mass dropped from 140mm above the surface)
	protected against 0.5 joules impact (equivalent to 0.25kg mass dropped from 200mm above the surface)
	protected against 0.7 joules impact (equivalent to 0.25kg mass dropped from 280mm above the surface)
	protected against 1 joules impact (equivalent to 0.25kg mass dropped from 400mm above the surface)
	protected against 2 joules impact (equivalent to 0.5kg mass dropped from 400mm above the surface)
	protected against 5 joules impact (equivalent to 1.7kg mass dropped from 300mm above the surface)
	protected against 10 joules impact (equivalent to 5.0kg mass dropped from 200mm above the surface)
	protected against 20 joules impact (equivalent to 5.0kg mass dropped from 400mm above the surface)